

MITSUBISHI IGBT MODULES  
**CM100DU-12F**

HIGH POWER SWITCHING USE

**CM100DU-12F**



- IC ..... 100A
- VCES ..... 600V
- Insulated Type
- 2-elements in a pack

**APPLICATION**

General purpose inverters & Servo controls, etc

**OUTLINE DRAWING & CIRCUIT DIAGRAM**

Dimensions in mm

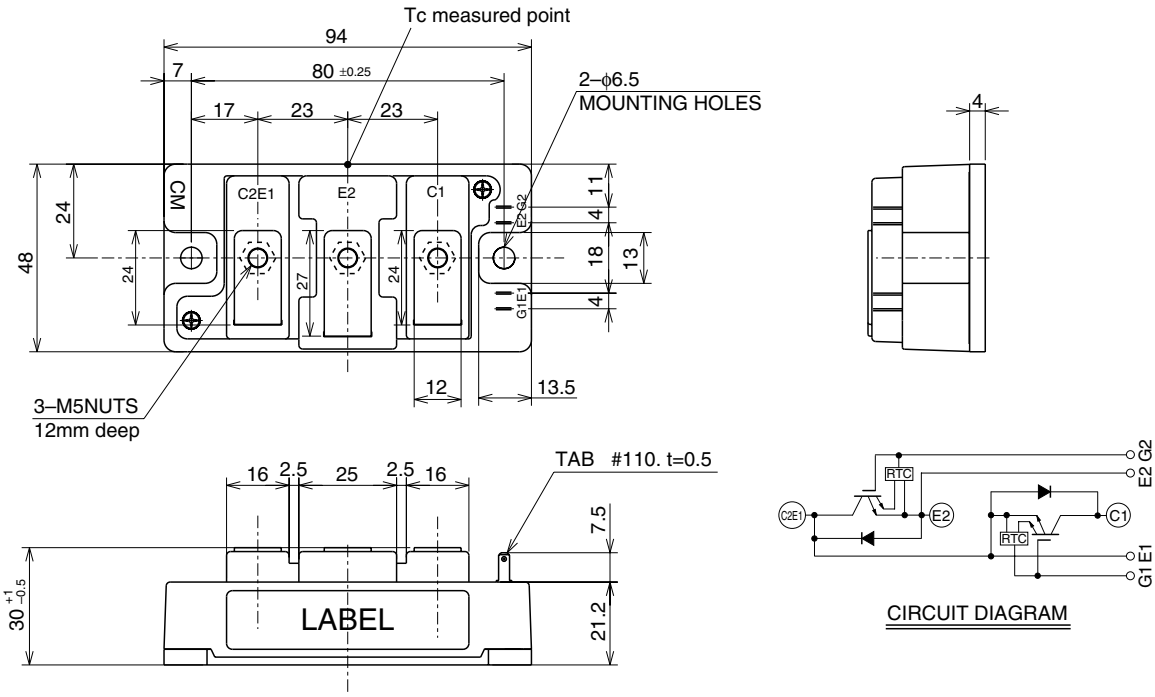

CM100DU-12F

HIGH POWER SWITCHING USE

MAXIMUM RATINGS (T<sub>J</sub> = 25°C, unless otherwise specified)

Symbol	Parameter	Conditions	Ratings	Unit
V <sub>CE</sub> S	Collector-emitter voltage	G-E Short	600	V
V <sub>GE</sub> S	Gate-emitter voltage	C-E Short	±20	V
I <sub>C</sub>	Collector current	T <sub>C</sub> = 25°C	100	A
I <sub>CM</sub>		Pulse (Note 2)	200	A
I <sub>E</sub> (Note 1)	Emitter current	T <sub>C</sub> = 25°C	100	A
I <sub>EM</sub> (Note 1)		Pulse (Note 2)	200	A
P <sub>C</sub> (Note 3)	Maximum collector dissipation	T <sub>C</sub> = 25°C	350	W
T <sub>J</sub>	Junction temperature		-40 ~ +150	°C
T <sub>stg</sub>	Storage temperature		-40 ~ +125	°C
V <sub>iso</sub>	Isolation voltage	Charged part to base plate, f = 60Hz, AC 1 minute	2500	V <sub>rms</sub>
—	Torque strength	Main terminals M5 screw	2.5 ~ 3.5	N • m
		Mounting M6 screw	3.5 ~ 4.5	N • m
—	Weight	Typical value	310	g

ELECTRICAL CHARACTERISTICS (T<sub>J</sub> = 25°C, unless otherwise specified)

Symbol	Parameter	Test conditions	Limits			Unit
			Min.	Typ.	Max.	
I <sub>CE</sub> S	Collector cutoff current	V <sub>CE</sub> = V <sub>CE</sub> S, V <sub>GE</sub> = 0V	—	—	1	mA
V <sub>GE(th)</sub>	Gate-emitter threshold voltage	I <sub>C</sub> = 10mA, V <sub>CE</sub> = 10V	5	6	7	V
I <sub>GES</sub>	Gate leakage current	±V <sub>GE</sub> = V <sub>GES</sub> , V <sub>CE</sub> = 0V	—	—	20	μA
V <sub>CE(sat)</sub>	Collector-emitter saturation voltage	I <sub>C</sub> = 100A, V <sub>GE</sub> = 15V	T <sub>J</sub> = 25°C		2.2	V
			T <sub>J</sub> = 125°C		—	
C <sub>ies</sub>	Input capacitance	V <sub>CE</sub> = 10V V <sub>GE</sub> = 0V	—	—	27	nF
C <sub>oes</sub>	Output capacitance		—	—	1.8	nF
C <sub>res</sub>	Reverse transfer capacitance		—	—	1	nF
Q <sub>G</sub>	Total gate charge	V <sub>CC</sub> = 300V, I <sub>C</sub> = 100A, V <sub>GE</sub> = 15V	—	620	—	nC
t <sub>d(on)</sub>	Turn-on delay time	V <sub>CC</sub> = 300V, I <sub>C</sub> = 100A V <sub>GE</sub> = ±15V R <sub>G</sub> = 6.3Ω, Inductive load I <sub>E</sub> = 100A	—	—	100	ns
t <sub>r</sub>	Turn-on rise time		—	—	80	ns
t <sub>d(off)</sub>	Turn-off delay time		—	—	300	ns
t <sub>f</sub>	Turn-off fall time		—	—	250	ns
t <sub>rr</sub> (Note 1)	Reverse recovery time		—	—	150	ns
Q <sub>rr</sub> (Note 1)	Reverse recovery charge		—	1.9	—	μC
V <sub>EC</sub> (Note 1)	Emitter-collector voltage	I <sub>E</sub> = 100A, V <sub>GE</sub> = 0V	—	—	2.6	V
R <sub>th(j-c)Q</sub>	Thermal resistance*1	IGBT part (1/2 module)	—	—	0.35	K/W
R <sub>th(j-c)R</sub>		FWDi part (1/2 module)	—	—	0.70	K/W
R <sub>th(c-f)</sub>	Contact thermal resistance	Case to heat sink, Thermal compound applied*2 (1/2 module)	—	0.07	—	K/W
R <sub>th(j-c')Q</sub>	Thermal resistance	Case temperature measured point is just under the chips	—	—	0.28*3	K/W
R <sub>G</sub>	External gate resistance		6.3	—	63	Ω

Note 1. I<sub>E</sub>, V<sub>EC</sub>, t<sub>rr</sub>, Q<sub>rr</sub> & die/dt represent characteristics of the anti-parallel, emitter-collector free-wheel diode (FWDi).  
 2. Pulse width and repetition rate should be such that the device junction temperature (T<sub>J</sub>) does not exceed T<sub>Jmax</sub> rating.  
 3. Junction temperature (T<sub>J</sub>) should not increase beyond 150°C.  
 \*1 : Case temperature (T<sub>C</sub>) measured point is indicated in OUTLINE DRAWING.  
 \*2 : Typical value is measured by using thermally conductive grease of λ = 0.9[W/(m • K)].  
 \*3 : If you use this value, R<sub>th(f-a)</sub> should be measured just under the chips.

PERFORMANCE CURVES

OUTPUT CHARACTERISTICS (TYPICAL)

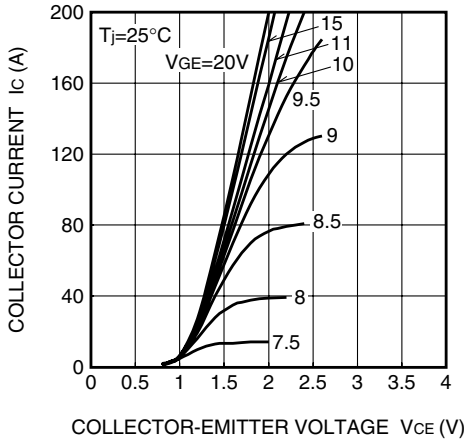

COLLECTOR-EMITTER SATURATION VOLTAGE CHARACTERISTICS (TYPICAL)

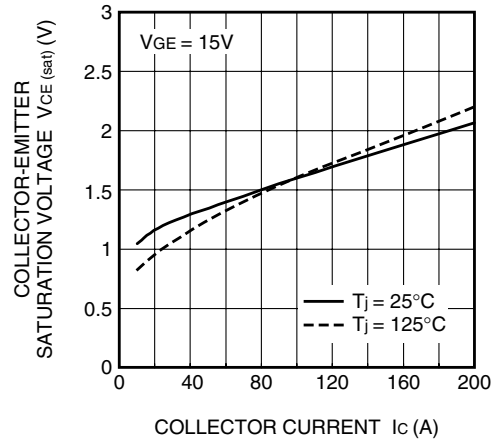

COLLECTOR-EMITTER SATURATION VOLTAGE CHARACTERISTICS (TYPICAL)

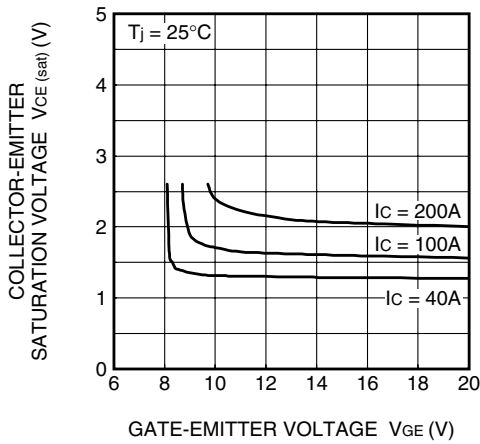

FREE-WHEEL DIODE FORWARD CHARACTERISTICS (TYPICAL)

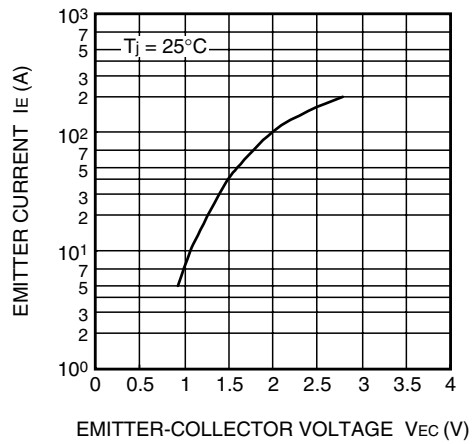

CAPACITANCE- $V_{CE}$  CHARACTERISTICS (TYPICAL)

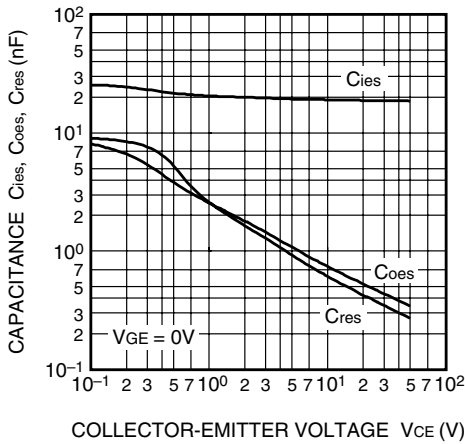

HALF-BRIDGE SWITCHING CHARACTERISTICS (TYPICAL)

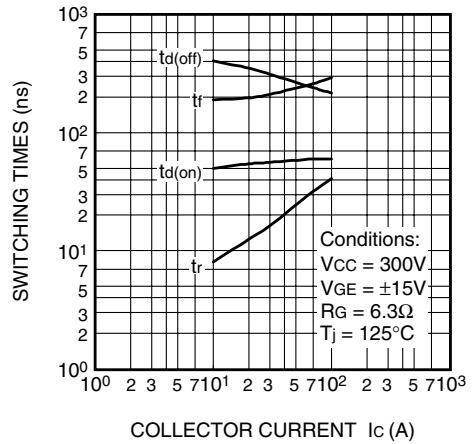

CM100DU-12F

HIGH POWER SWITCHING USE

REVERSE RECOVERY CHARACTERISTICS OF FREE-WHEEL DIODE (TYPICAL)

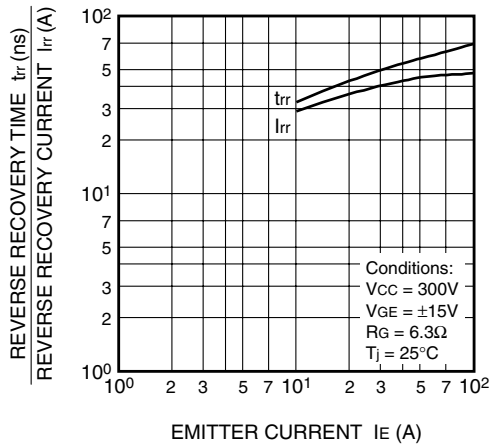

TRANSIENT THERMAL IMPEDANCE CHARACTERISTICS (IGBT part & FWDi part)

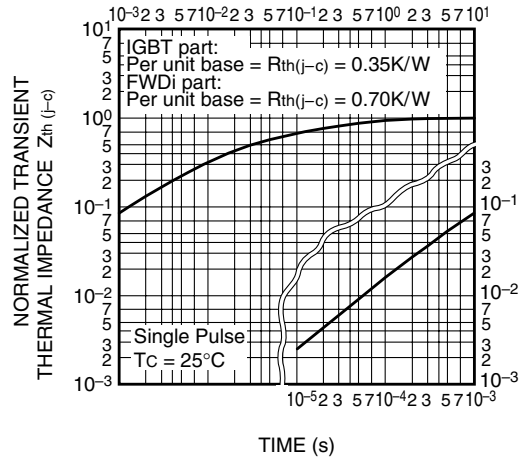

GATE CHARGE CHARACTERISTICS (TYPICAL)

